

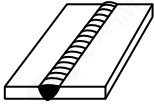

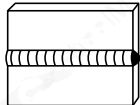

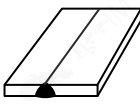

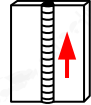



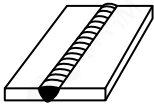
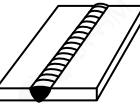
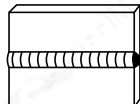
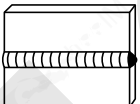

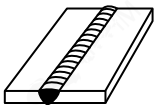
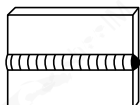
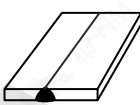
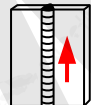

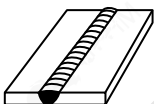

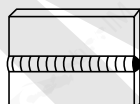
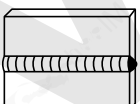

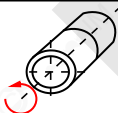

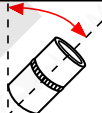
			1	2	3	4	5	6	7	8	9	10
0	1 E1 St (PersZert)	90 0 90										
0	1 E2 St (PersZert)	76 4 80										
0	1 E3 St (PersZert)	80 0 80										
0	1 E4 St (PersZert)	76 4 80										
0	1 E5 St (PersZert)	75 5 80										
0	1 E6 St (PersZert)	92 12 104										

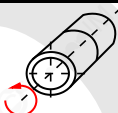
			1	2	3	4	5	6	7	8	9	10
0	1 M2 AI (PersZert)	76 4 80										
0	1 M2 St (PersZert)	76 4 80										
0	1 M3 AI (PersZert)	76 4 80										
0	1 M3 St (PersZert)	72 8 80										
0	1 M4 AI (PersZert)	80 4 84										
0	1 M4 St (PersZert)	72 8 80										

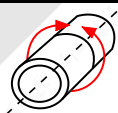
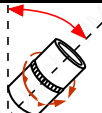
			1	2	3	4	5	6	7	8	9	10
0	1 M5 St (PersZert)	76 4 80										
0	1 M6 St (PersZert)	76 4 80										
0	1 T1 Al (PersZert)	80 0 80										
0	1 T1 St (PersZert)	80 0 80										
0	1 T2 Al (PersZert)	80 0 80										
0	1 T2 St (PersZert)	76 4 80										

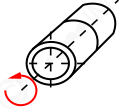
			1	2	3	4	5	6	7	8	9	10
0	1 T3 Al (PersZert)	56 0 56										
0	1 T3 St (PersZert)	56 0 56										
0	1 T4 Al (PersZert)	76 4 80										
0	1 T4 St (PersZert)	76 4 80										
0	1 T5 Al (PersZert)	120 0 120										
0	1 T5 St (PersZert)	120 0 120										

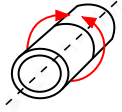
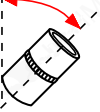
			1	2	3	4	5	6	7	8	9	10
0	1 T6 Al (PersZert)	56 4 60										
0	1 T6 St (PersZert)	60 4 64	